



OM-231 425-B

2006-11

Auto-Darkening Helmets

Performance Series™ Pro-Hobby™ Series



To help us serve you better, go to www.MillerWelds.Com/Helmet/Reg/



TABLE OF CONTENTS

SECTION 1 – SAFETY PRECAUTIONS –READ BEFORE USING	1
1-1. Symbol Usage	1
1-2. Hazards	1
SECTION 2 – SPECIFICATIONS	2
SECTION 3 – OPERATING INSTRUCTIONS – PRO-HOBBY SERIES HELMETS	3
3-1. Helmet Controls – Pro-Hobby Series Helmets	3
3-2. On Button And Low Battery Indicator (Pro-Hobby Series Variable Shade Helmets)	4
3-3. Lens Delay Control (Pro-Hobby Series Variable Shade Helmets)	4
3-4. Variable Shade Control (No. 8 – 12) (Pro-Hobby Series Variable Shade Helmets)	5
3-5. Sensitivity Control (Pro-Hobby Series Variable Shade Helmets)	6
SECTION 4 – OPERATING INSTRUCTIONS – PERFORMANCE SERIES HELMETS	7
4-1. Helmet Controls – Performance Series Helmets	7
4-2. Reset Button And Low Battery Indicator (Performance Series Helmets)	8
4-3. Lens Delay Control (Performance Series Helmets)	8
4-4. Variable Shade Control (No. 8 – 13) (Performance Series Helmets)	9
4-5. Sensitivity Control (Performance Series Helmets)	10
SECTION 5 – ADJUSTING HEADGEAR	11
SECTION 6 – REPLACING THE LENS COVERS	12
6-1. Replacing Outside Lens Cover – Pro-Hobby Series Helmets	12
6-2. Replacing Inside Lens Cover – Pro-Hobby Series Helmets	13
6-3. Replacing Outside Lens Cover – Performance Series Helmets	14
6-4. Replacing Inside Lens Cover – Performance Series Helmets	15
SECTION 7 – REPLACING THE BATTERY	16
7-1. Pro-Hobby Variable Shade Helmets	16
7-2. Pro-Hobby Fixed Shade No. 10 Helmets	16
7-3. Performance Series Helmets	17
SECTION 8 – INSTALLING OPTIONAL MAGNIFYING LENS	18
8-1. Pro-Hobby Series Helmets	18
8-2. Performance Series Helmets	19
SECTION 9 – MAINTENANCE	19
SECTION 10 – TROUBLESHOOTING	20
SECTION 11 – PARTS LIST	21
SECTION 12 – LIMITED WARRANTY	25



SECTION 1 – SAFETY PRECAUTIONS – READ BEFORE USING

▲ **Warning: Protect yourself and others from injury — read and follow these precautions.**



1-1. Symbol Usage

	<p>Means Warning! Watch Out! There are possible hazards with this procedure! The possible hazards are shown in the adjoining symbols.</p>	
<p>▲ Marks a special safety message.</p> <p> Means "Note"; not safety related.</p>	<p>This group of symbols means Warning! Watch Out! possible ELECTRIC SHOCK, MOVING PARTS, and HOT PARTS hazards. Consult symbols and related instructions below for necessary actions to avoid the hazards.</p>	

1-2. Hazards

	<p>ARC RAYS can burn eyes and skin.</p> <p>Arc rays from the welding process produce intense visible and invisible (ultraviolet and infrared) rays that can burn eyes and skin. Sparks fly off from the weld.</p> <ul style="list-style-type: none"> ● Wear a welding helmet fitted with a proper shade of filter to protect your face and eyes when welding or watching (see ANSI Z49.1 and Z87.1 listed in Safety Standards). Refer to Shade and Sensitivity charts in Sections 3 and 4. ● Wear approved safety glasses with side shields under your helmet. ● Use protective screens or barriers to protect others from flash and glare; warn others not to watch the arc. ● Wear protective clothing made from durable, flame-resistant material (leather and wool) and foot protection.
	<p>WELDING HELMETS do not provide unlimited eye, ear and face protection.</p> <ul style="list-style-type: none"> ● Use impact resistant safety spectacles or goggles and ear protection at all times when using this welding helmet. ● Do not use this helmet while working with or around explosives or corrosive liquids. ● Do not weld in the overhead position while using this helmet. ● Inspect the auto-lens frequently. Immediately replace any scratched, cracked, or pitted cover lenses or auto-lenses.
	<p>NOISE can damage hearing.</p> <p>Noise from some processes or equipment can damage hearing.</p> <ul style="list-style-type: none"> ● Wear approved ear protection if noise level is high.

SECTION 2 – SPECIFICATIONS

Specification	Pro-Hobby Variable Shade Helmet	Pro-Hobby Fixed Shade No. 10 Helmet	Performance Helmet
Viewing Field	95 x 40mm (3.75 x 1.55 in)	95 x 35mm (3.75 x 1.375 in)	97 x 47 mm (3.81 x 1.85 in)
Reaction Time	0.000083 sec (1/12,000)	0.000277 sec (1/3,600)	0.0000500 sec (1/20,000)
Available Shades	Darkened State: No. 8 – No. 12 Light State: No. 3 Provides continuous UV and IR protection	Darkened State: No. 10 Light State: No. 3 Provides continuous UV and IR protection	Darkened State: No. 8 – No. 13 Light State: No. 3 Provides continuous UV and IR protection
Sensitivity Control	Adjusts for varying ambient light and welding arc	Not Applicable	Adjusts for varying ambient light and welding arc
Delay Control	Slows lens dark-to-light state (slow – fast)	Not Applicable	Slows lens dark-to-light state between 0.1 and 1.0 seconds
Automatic Power Off	Shuts lens Off 15–20 minutes after last arc is struck		
Low Battery Indicator	Red LED light illuminates to indicate 2–3 days remaining battery life	Not Applicable	Red LED light illuminates to indicate 2–3 days remaining battery life
Power Supply	AAA Lithium Batteries Only (Two)	Rechargeable, non-re- placeable solar cell	CR2450 lithium battery (Miller Part No. 217 043)
Sensors	Independent/Redundant (Two)		Independent/Redun- dant (Three)
Operating Temperature	14°F to 131°F / –10°C to +55°C  When stored in extremely cold temperatures, warm helmet to ambient temperature before welding.		
Storage Temperature	–4°F to 158°F / –20°C to +70°C  When stored in extremely cold temperatures, warm helmet to ambient temperature before welding.		
Total Weight	453.6g (16oz.)		481.9 g (17 oz.)
Standards	ANSI Z87.1 and CSA		
Warranty	2 years from date of purchase (see Section 12)		

 The helmets in this manual are covered by one or more of the following patents:
 U.S. Patent – No. 6,552,316, No. 6,483,090, No. 6,614,409
 U.S. Patent Application – No. 29/223,100, No. 11/053,977
 DE. Patent – No. 199 59 944 C2, No. 199 59 945 C2
 FR. Patent – No. 9916004

SECTION 3 – OPERATING INSTRUCTIONS – PRO-HOBBY SERIES HELMETS

3-1. Helmet Controls – Pro-Hobby Series Helmets

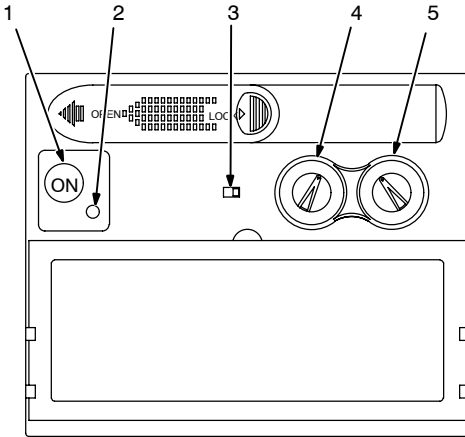
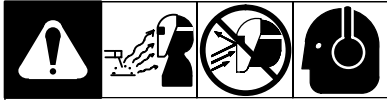

Variable Shade Lens Assembly

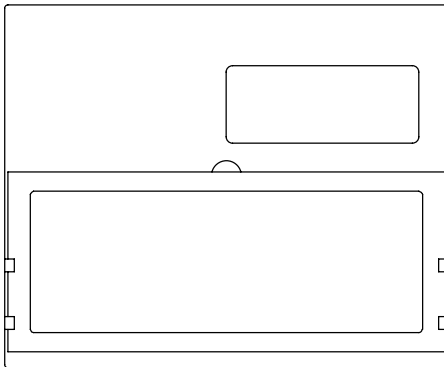

Fixed Shade No. 10 Lens Assembly

☞ Two different lens assemblies are shown. Refer to the illustration that matches the lens on your helmet.

Variable Shade Model

- 1 On Button (See Section 3-2)
- 2 Low Battery Indicator (See Section 3-2)
- 3 Lens Delay Control (See Section 3-3)
- 4 Variable Shade Control (No. 8 – 12) (See Section 3-4)
- 5 Sensitivity Control (See Section 3-5)

Fixed Shade No. 10 Model

The fixed shade model has no buttons or controls. The lens turns on (darkens) automatically when welding begins and turns off when welding stops.

☞ Always make sure the lens is fully charged before welding. Place helmet in direct sunlight for 20 minutes to charge the lens assembly solar cell.

3-2. On Button And Low Battery Indicator (Pro-Hobby Series Variable Shade Helmets)

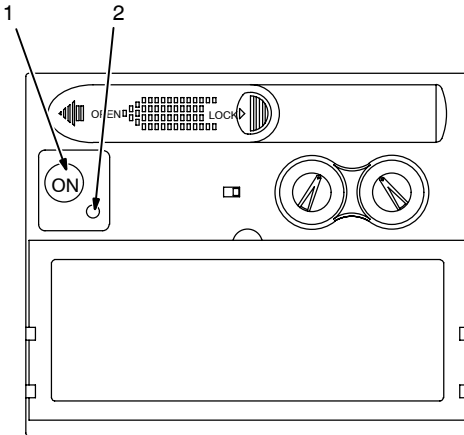

1 On Button

Press button to turn on lens and begin welding. The lens will automatically darken twice and then return to the light state.

The lens will automatically turn Off (clear state – No. 3) 15–20 minutes after the last arc. Press the On button to resume welding.

2 Low Battery Indicator

The low battery indicator lights when 2–3 days of battery life remain.

If battery power is low, replace with AAA Lithium Batteries only (see Section 7).

804 792

3-3. Lens Delay Control (Pro-Hobby Series Variable Shade Helmets)

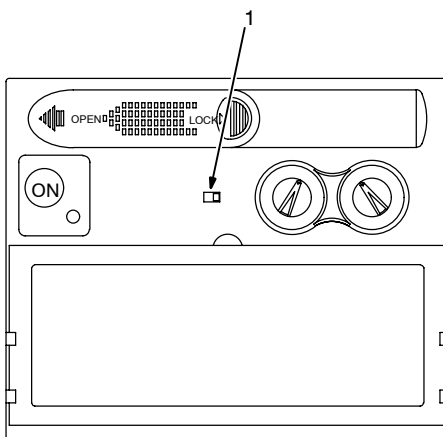

1 Lens Delay Control

The lens delay control is used to adjust the time for the lens to switch to the clear state after welding.

The delay is particularly useful in eliminating bright after-rays present in higher amperage applications where the molten puddle remains bright momentarily after welding. Adjusts from slow to fast.

804 792

3-4. Variable Shade Control (No. 8 – 12) (Pro-Hobby Series Variable Shade Helmets)



1 Variable Shade Control (No. 8 – 12)

Use the control to adjust the lens shade in the darkened state. Use the table below to select proper shade control setting based on your welding process.

Start at shade 12 and adjust lighter to suit the welding application and your personal preference.

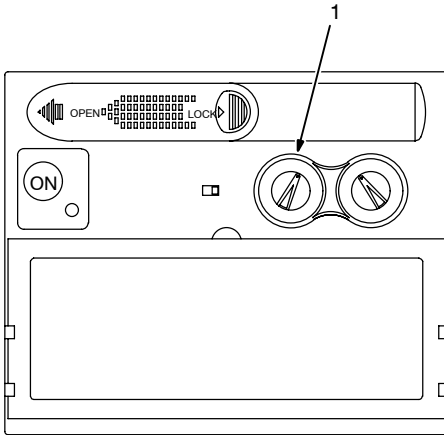

804 792

Application Welding	Arc Current in Amperes	Protective Shade No.
Stick Electrodes	Less than 40	9
	40–80	10
	80–175	11
	175–300	12
	300–500	13
MIG	Less than 100	10
	100–175	11
	175–300	12
	300–500	13
Gas Tungsten Arc Welding (TIG)	Less than 50	10
	50–100	11
	100–200	12
	200–400	13
Air Carbon	Less than 500	12
	500–700	13
Plasma Arc Cutting	60–150	11
	150–250	12
	250–400	13
Plasma Arc Welding	Less than 50	9
	50–200	10
	200–400	12

3-5. Sensitivity Control (Pro-Hobby Series Variable Shade Helmets)

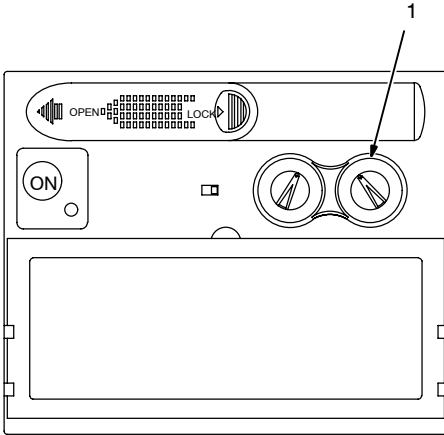
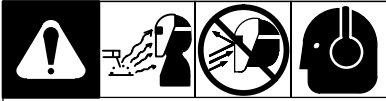

1 Sensitivity Control

Use control to make the lens more responsive to different light levels in various welding processes. **Use a Mid-Range or 30-50% sensitivity setting for most applications.**

It may be necessary to adjust helmet sensitivity to accommodate different lighting conditions or if lens is flashing On and Off. Adjust helmet sensitivity as follows:

Adjust helmet sensitivity in lighting conditions helmet will be used in.

- Turn sensitivity control to lowest setting.
- Press On button to turn helmet On. Helmet lens will darken twice and then clear.
- Face the helmet in the direction of use, exposing it to the surrounding light conditions.
- Gradually turn sensitivity setting clockwise until the lens darkens, then turn sensitivity control counterclockwise until slightly past setting where lens clears. Helmet is ready for use. Slight readjustment may be necessary for certain applications or if lens is flashing on and off.

804 792

Recommended Sensitivity Settings

Stick Electrode	Mid-Range
Short Circuiting (MIG)	Low/Mid-Range
Pulsed & Spray (MIG)	Mid-Range
Gas Tungsten Arc (TIG)	Mid/High-Range
Plasma Arc Cutting/Welding	Low/Mid-Range

SECTION 4 – OPERATING INSTRUCTIONS – PERFORMANCE SERIES HELMETS

4-1. Helmet Controls – Performance Series Helmets

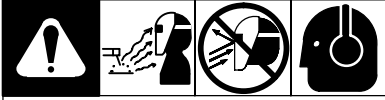

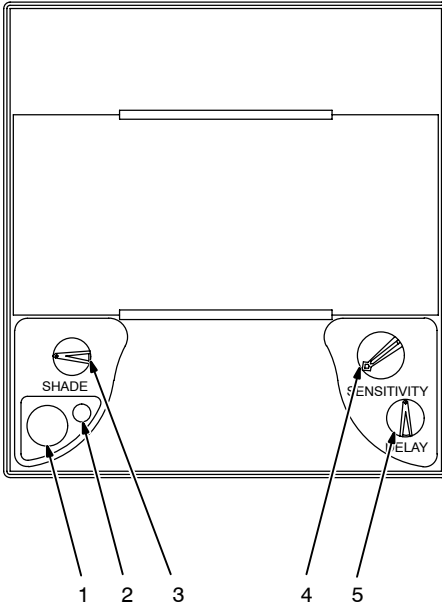

The lens on performance series helmets turns on (darkens) automatically when welding begins and turns off when welding stops.

- 1 Reset Button
(See Section 4-2)
- 2 Low Battery Indicator
(See Section 4-2)
- 3 Variable Shade Control
(No. 8 – 13) (See Section 4-4)
- 4 Sensitivity Control
(See Section 4-5)
- 5 Lens Delay Control (See
Section 4-3)

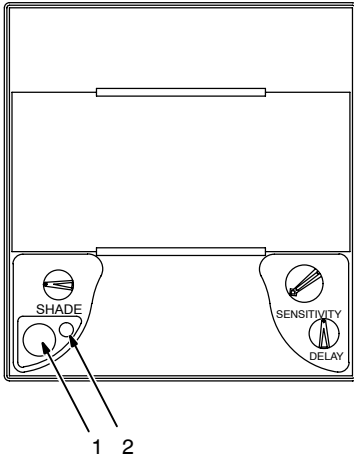
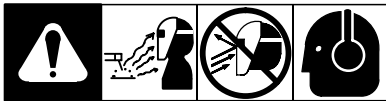

4-2. Reset Button And Low Battery Indicator (Performance Series Helmets)



 The auto-darkening lens on Performance series helmets turns on (darkens) automatically when welding begins and turns off when welding stops.

1 Reset Button

Press Reset button to check if the lens is working properly.

When the Reset button is pressed, the lens should darken twice and return to the clear state. Do not use the helmet if the lens does not function as described. (See Section 10, Troubleshooting.)

2 Low Battery Indicator

The low battery indicator lights when 2-3 days of battery life remain.

If battery power is low, replace with CR2450 lithium battery (Miller Part No. 217 043) (see Section 7-3).

804 815

4-3. Lens Delay Control (Performance Series Helmets)

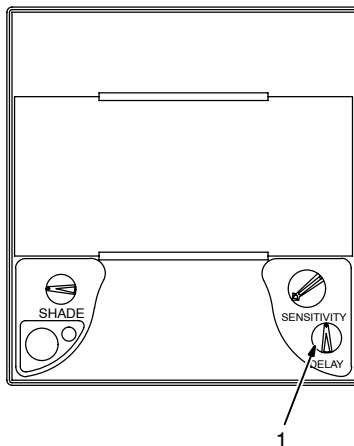

1 Lens Delay Control

The lens delay control is used to adjust the time for the lens to switch to the clear state after welding.

The delay is particularly useful in eliminating bright after-rays present in higher amperage applications where the molten puddle remains bright momentarily after welding. Adjusts from slow to fast.

804 815

4-4. Variable Shade Control (No. 8 – 13) (Performance Series Helmets)

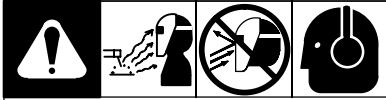

1 Variable Shade Control (No. 8 – 13)

Use the control to adjust the lens shade in the darkened state. Use the table below to select proper shade control setting based on your welding process.

Start at shade 12 and adjust lighter to suit the welding application and your personal preference.

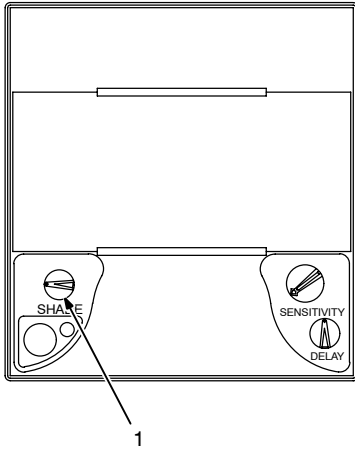

804 815

Application Welding	Arc Current in Amperes	Protective Shade No.
Stick Electrodes	Less than 40	9
	40–80	10
	80–175	11
	175–300	12
	300–500	13
MIG	Less than 100	10
	100–175	11
	175–300	12
	300–500	13
Gas Tungsten Arc Welding (TIG)	Less than 50	10
	50–100	11
	100–200	12
	200–400	13
Air Carbon	Less than 500	12
	500–700	13
Plasma Arc Cutting	60–150	11
	150–250	12
	250–400	13
Plasma Arc Welding	Less than 50	9
	50–200	10
	200–400	12

4-5. Sensitivity Control (Performance Series Helmets)

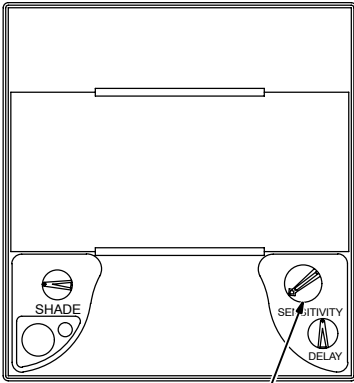
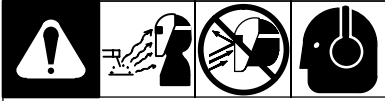

1 Sensitivity Control

Weld Mode

Use control to make the lens more responsive to different light levels in various welding processes. **Use a Mid-Range or 30–50% sensitivity setting for most applications.**

It may be necessary to adjust helmet sensitivity to accommodate different lighting conditions or if lens is flashing On and Off. Adjust helmet sensitivity as follows:

Adjust helmet sensitivity in lighting conditions helmet will be used in.

- Turn sensitivity control to lowest setting.
- Press Reset button to turn helmet On. Helmet lens will darken twice and then clear.
- Face the helmet in the direction of use, exposing it to the surrounding light conditions.
- Gradually turn sensitivity setting clockwise until the lens darkens, then turn sensitivity control counterclockwise until slightly past setting where lens clears. Helmet is ready for use. Slight readjustment may be necessary for certain applications or if lens is flashing on and off.

Grind Mode

Do not weld in the Grind mode; the lens will not darken.

To use the Grind mode, turn the Sensitivity control counterclockwise to the far left position (Grind). To resume welding, return the control to the desired sensitivity setting.

804 815

Recommended Sensitivity Settings

Stick Electrode	Mid-Range
Short Circuiting (MIG)	Low/Mid-Range
Pulsed & Spray (MIG)	Mid-Range
Gas Tungsten Arc (TIG)	Mid/High-Range
Plasma Arc Cutting/Welding	Low/Mid-Range

SECTION 5 – ADJUSTING HEADGEAR

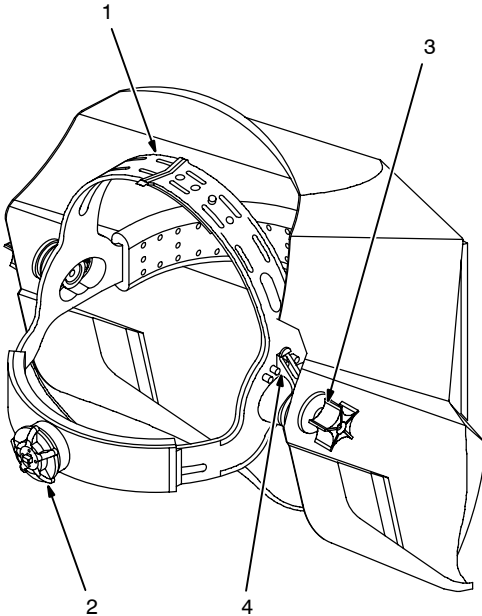
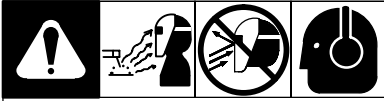

☞ *There are four headgear adjustments: headgear top, tightness, distance adjustment, and angle adjustment.*

1 Headgear Top Adjustment

Adjusts headgear for proper depth on the head to ensure correct balance and stability.

2 Headgear Tightness Adjustment

Adjusts headgear for a secure fit. To adjust, push in the adjusting knob located on the back of the headgear. Turn knob left or right to obtain desired tightness.

☞ *If adjustment is limited, it may be necessary to remove the comfort cushion.*

3 Distance Adjustment

Adjusts the distance between the face and the lens. To adjust, loosen both outside tension knobs and press inward to free from adjustment slots. Move forward or back to desired position and retighten. (Both sides must be equally positioned for proper vision.)

4 Angle Adjustment

Four pins on the right side of the headband/top provide adjustment for the forward tilt of the helmet. To adjust, loosen the right outside tension adjustment knob then lift on the control arm tab and move it to the desired position. Retighten tension adjustment knob.

☞ *When using the back distance adjustment position, only the back three angle adjustment pins can be used.*

SECTION 6 – REPLACING THE LENS COVERS

6-1. Replacing Outside Lens Cover – Pro-Hobby Series Helmets



▲ **Never use the auto-darkening lens without the inside and outside lens covers properly installed. Welding spatter will damage the auto-darkening lens and void the warranty.**

- 1 Outside Lens Cover Frame
- 2 Lens Cover
- 3 Gasket

Remove lens cover frame by grasping the outside corners and pulling the frame away from the helmet.

Remove lens cover and gasket from the six-prong lens frame. Replace lens cover and reinstall gasket and lens in frame. Reinstall frame in helmet.

☞ *Be sure the flat side of lens gasket faces the six-prong lens frame.*

☞ *Be sure all six prongs of lens frame are securely fastened in slots in helmet.*

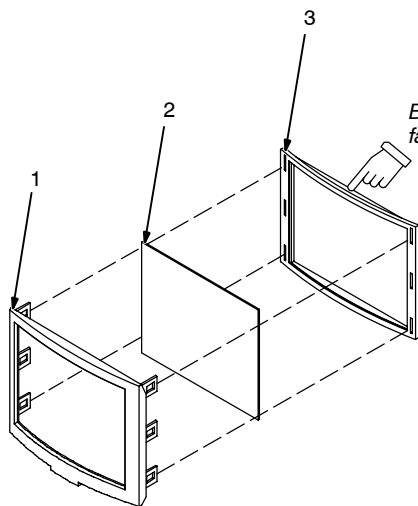
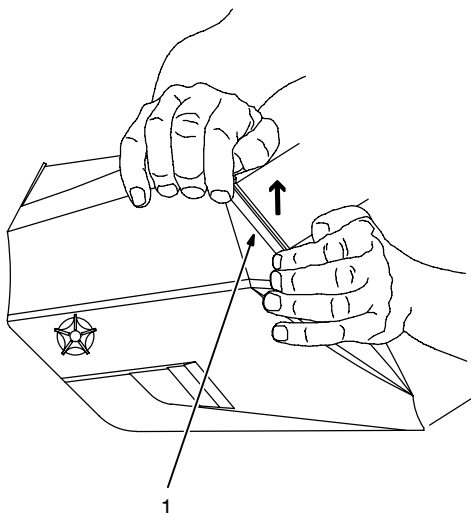

Be sure flat side of gasket faces lens frame.

6-2. Replacing Inside Lens Cover – Pro-Hobby Series Helmets

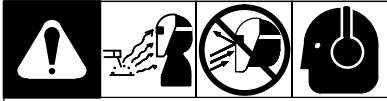

- ▲ **Never use the auto-darkening lens without the inside and outside lens covers properly installed. Welding spatter will damage the auto-darkening lens and void the warranty.**

1 inside Lens Cover

Remove the inside lens cover by prying the lens up at the thumbnail opening located at the top center of the lens cover.

Replace the lens cover by gently bowing it in the center and inserting it, one end at a time, into the retaining clips located on the outside of the auto-darkening lens assembly.

 *Be sure the cover lens is seated properly (flat) to prevent fogging.*

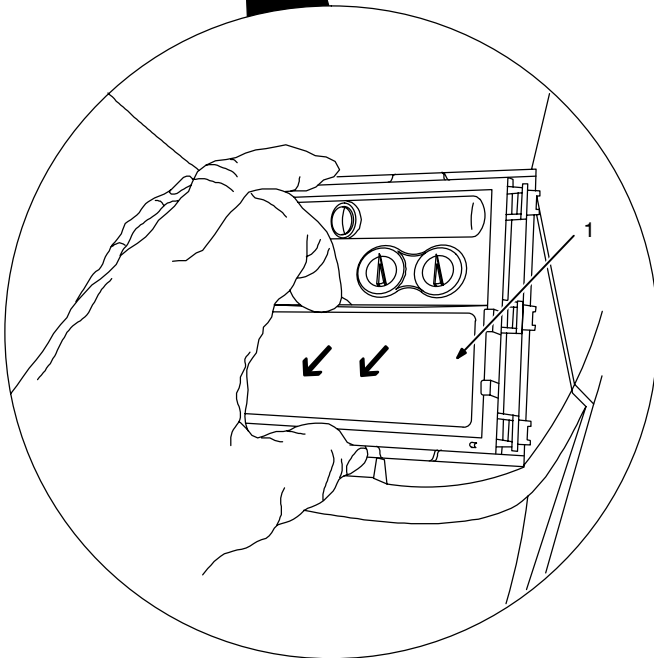
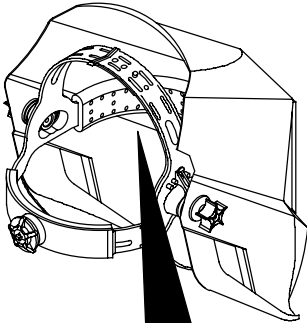

6-3. Replacing Outside Lens Cover – Performance Series Helmets

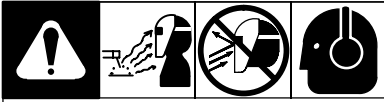

▲ **Never use the auto-darkening lens without the inside and outside lens covers properly installed. Welding spatter will damage the auto-darkening lens and void the warranty.**

- 1 Front Lens Holder
- 2 Release Points
- 3 Lens Cover
- 4 Gasket

Remove front lens holder by pressing release points and pulling the holder away from the helmet.

Remove lens cover and gasket from the holder. Replace lens cover and reinstall gasket and lens in holder. Reinstall holder in helmet.

☞ *Be sure the flat side of lens cover gasket faces the lens cover holder.*

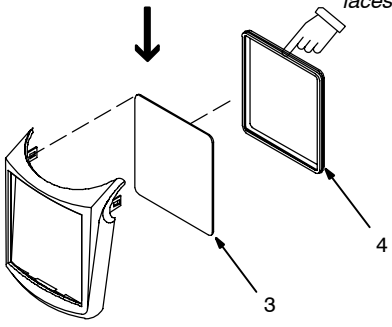
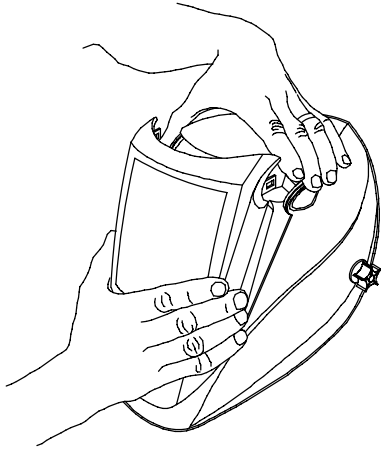
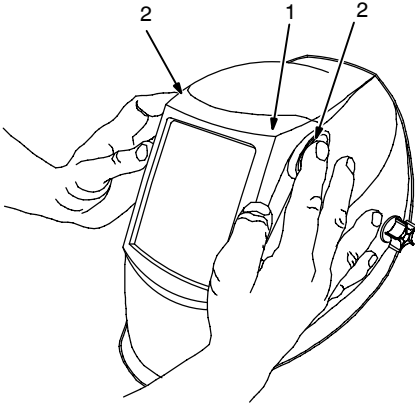

Be sure flat side of gasket faces lens cover holder.

6-4. Replacing Inside Lens Cover – Performance Series Helmets

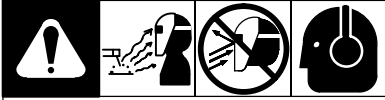

▲ **Never use the auto-darkening lens without the inside and outside lens covers properly installed. Welding spatter will damage the auto-darkening lens and void the warranty.**

- 1 Lens Assembly
- 2 inside Lens Cover

Remove the lens cover holder (see Section 6-3). Remove lens assembly.

Remove the inside lens cover by prying the cover up at either thumbnail opening at each side of the cover. Slide cover it out of either side of frame. Replace lens cover and reinstall the assembly in the helmet by reversing the above procedure.

 *Be sure the cover lens is seated properly (flat) to prevent fogging.*

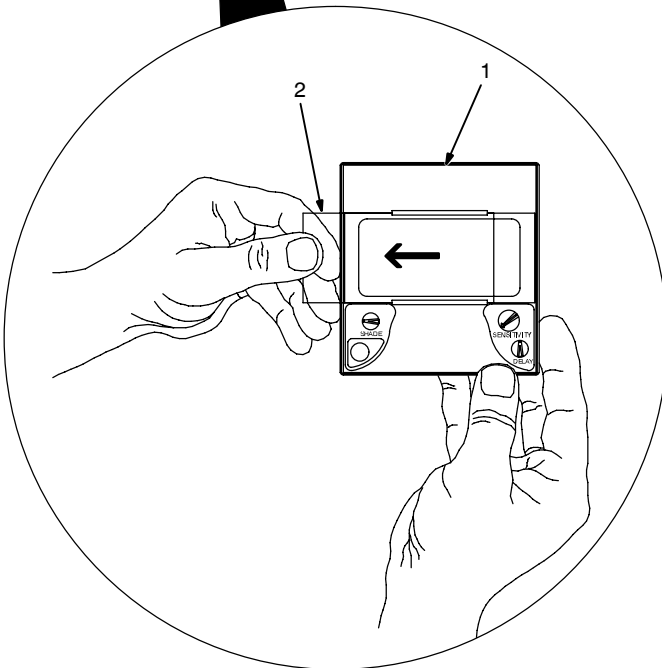
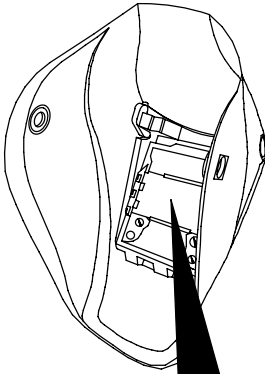

SECTION 7 – REPLACING THE BATTERY

7-1. Pro-Hobby Variable Shade Helmets

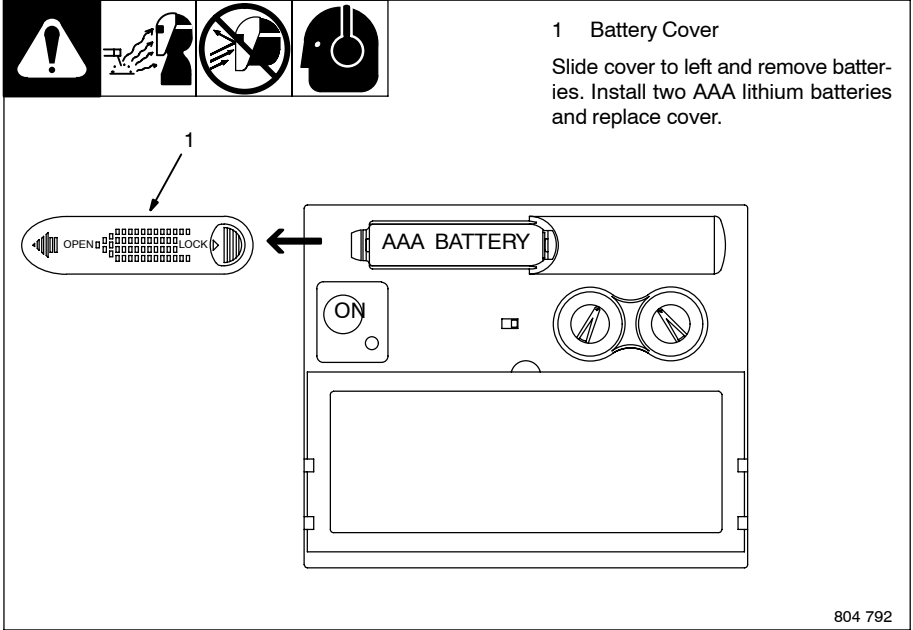

7-2. Pro-Hobby Fixed Shade No. 10 Helmets

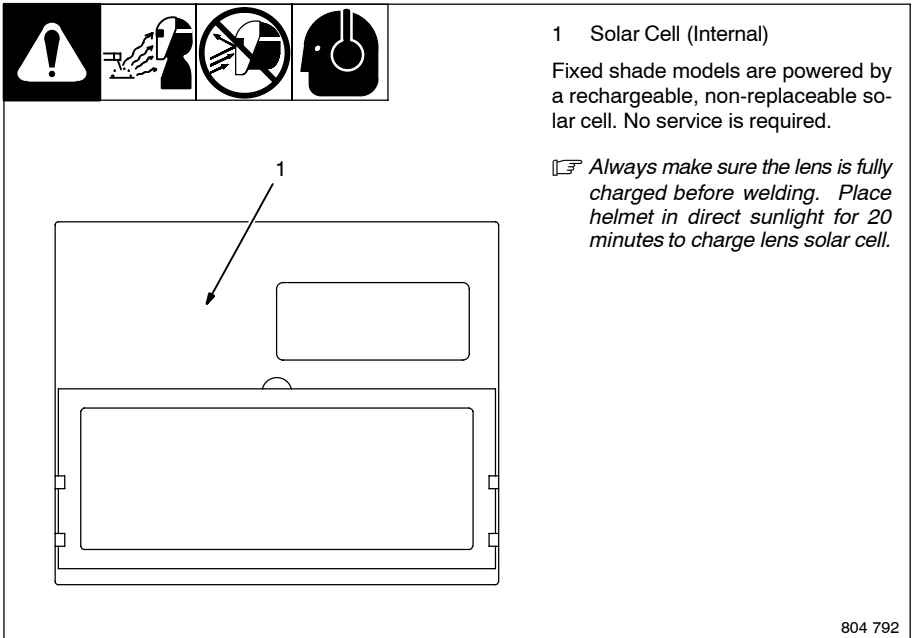

7-3. Performance Series Helmets

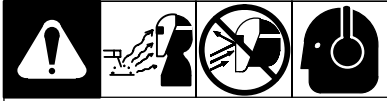

1 Battery Holder Latch

Push battery holder latch to the left and pull holder away from lens assembly. Install CR2450 lithium battery (Miller Part No. 217 043) and replace battery holder.

 *Be sure Positive (+) side of the battery faces up (toward inside of helmet).*

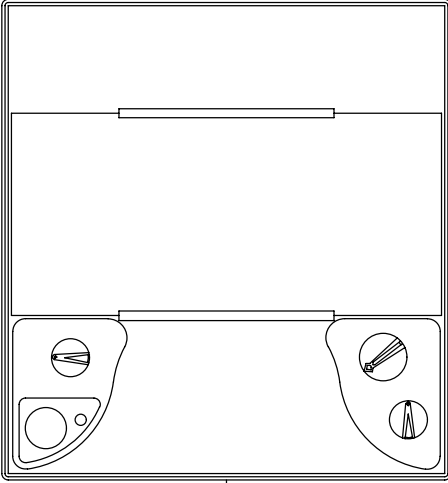

Be sure Positive (+) side of battery faces up.

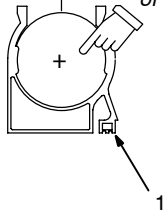

SECTION 8 – INSTALLING OPTIONAL MAGNIFYING LENS

8-1. Pro-Hobby Series Helmets

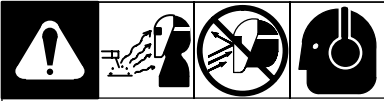

- 1 Outside Lens Cover Frame
- 2 Optional Magnifying Lens

Remove lens cover frame by grasping the outside corners and pulling the frame away from the helmet.

Remove the auto-darkening lens assembly by gently lifting the helmet lip above the assembly and pushing assembly free of the retaining brackets.

Starting at the top, slide magnifying lens into the helmet retaining brackets. Position the lens tightly against the bottom holding pins.

Reinstall auto-darkening lens assembly and lens cover frame.

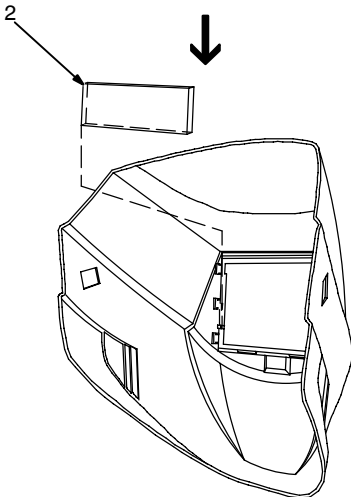
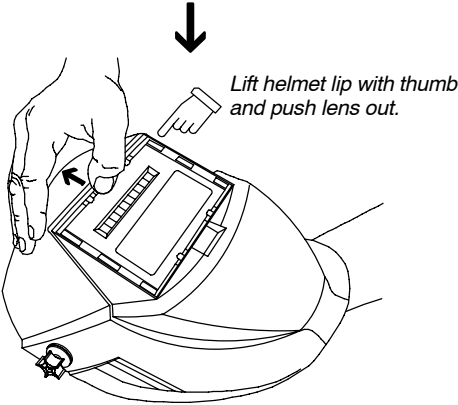
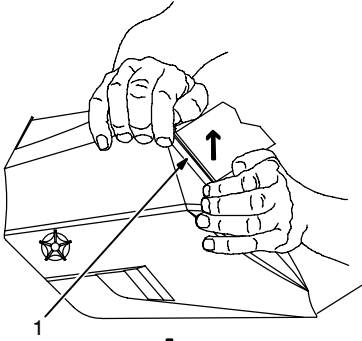

8-2. Performance Series Helmets

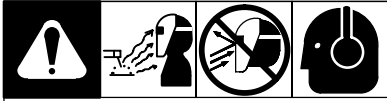

1 Optional Magnifying Lens

Starting at the top, slide magnifying lens into the helmet retaining brackets. Align the magnifying lens with the auto-darkening lens assembly.

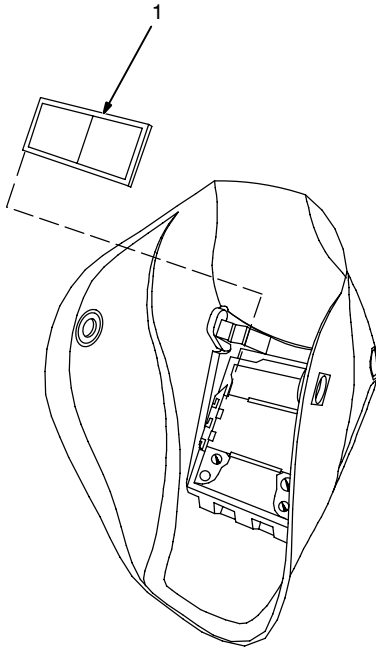

804 818

SECTION 9 – MAINTENANCE

 *Never use solvents or abrasive cleaning detergents. Do not immerse the lens assembly in water.*

The helmet requires little maintenance. However, for best performance clean after each use. Using a soft cloth dampened with a mild soap and water solution, wipe the cover lenses clean. Allow to air dry. Occasionally, the filter lens and sensors should be cleaned by gently wiping with a soft, dry cloth.

SECTION 10 – TROUBLESHOOTING



Trouble	Remedy
Auto lens not On; lens does not darken momentarily when the On button (Pro-Hobby series) or Reset button (Performance series) is pressed.	Check batteries and verify they are in good condition and installed properly. Also, check battery surfaces and contacts and clean if necessary.
Auto lens not switching; lens stays light and does not darken when welding.	Stop welding immediately; Press the On button (Pro-Hobby series) or Reset button (Performance series) on variable shade helmets. On Performance series helmets, also make sure the Sensitivity control is not in the Grind mode. On fixed-shade helmets, make sure the lens solar cell is properly charged by placing the helmet in direct sunlight for 20 minutes. If power is on, review the sensitivity recommendations and adjust sensitivity. Clean lens cover and sensors of any obstructions. Make sure the sensors are facing the arc; angles of 45° or more may not allow the arc light to reach the sensors.
Auto lens not Switching; lens stays dark after the weld arc is extinguished, or the lens stays dark when no arc is present.	Fine-tune the sensitivity setting by making small adjustments to the control by turning it toward the "min" setting. In extreme light conditions, it may be necessary to reduce the surrounding light levels.
Sections of the auto-lens are not going dark; distinct lines separate the light and dark areas.	Stop welding immediately; The auto-lens may be cracked which can be caused by the impact of dropping the helmet. Weld spatter on the auto lens may also cause cracking. (The lens may need to be replaced; most cracked lenses are not covered by warranty).
Auto lens switching or Flickering; lens darkens then lightens while the welding arc is present.	Review the sensitivity setting recommendations and increase the sensitivity if possible. Be sure the arc sensors are not being blocked from direct access to the arc light. Check the lens cover for dirt and spatter that may be blocking the arc sensors. Increasing Lens Delay to Fast position may also reduce switching.
Inconsistent or lighter auto-lens shading in the dark-state, noticeable on the outside edges and corners.	Referred to as an angle of view effect, auto-darkening lenses have an optimum viewing angle. The optimum viewing angle is perpendicular or 90° to the surface of the auto-lens. When that angle of view varies in the dark-state, welders may notice slightly lighter areas at the outside edges and the corners of the lens. This is normal and does not represent any health or safety hazard. This effect may also be more noticeable in applications where magnifying lenses are used.

SECTION 11 – PARTS LIST

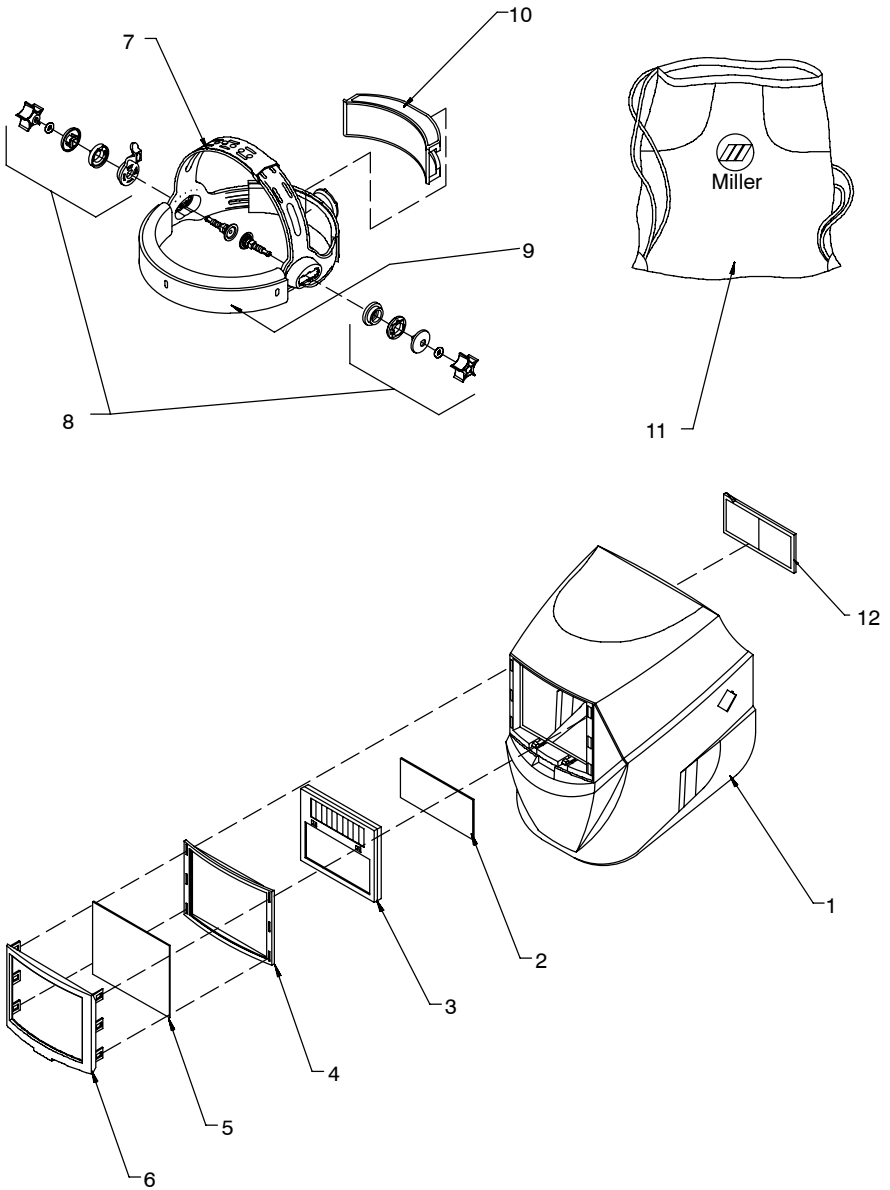

804 796

Figure 11-1. Pro-Hobby Series Auto-Darkening Welding Helmet

Item No.	Part No.	Description	Quantity
----------	----------	-------------	----------

Figure 11-1. Pro-Hobby Series Auto-Darkening Welding Helmet

1	231 415	Helmet Shell, Black	1
1	231 416	Helmet Shell, American Eagle II	1
1	231 419	Helmet Shell, Red Flame	1
1	231 417	Helmet Shell, Millermatic®	1
1	231 418	Helmet Shell, Camouflage	1
2	231 410	Lens Cover, Inside (4.25 – 1.75 in) (5 Per Pkg.)	1
3	231 409	Auto-Darkening Lens Assy. (Variable Shade)	1
3	231 571	Auto-Darkening Lens Assy. (Fixed Shade)	1
	231 413	Cover, Battery (Variable Shade)	1
4	231 412	Gasket, Front Lens	1
5	231 411	Lens, Front Cover (4.5 x 3.6875 in) (5 Per Pkg.)	1
6	231 572	Holder, Front Lens (Black)	1
6	231 573	Holder, Front Lens (Gray)	1
6	231 574	Holder, Front Lens (Red)	1
6	231 575	Holder, Front Lens (Blue)	1
6	231 576	Holder, Front Lens (Camouflage)	1
7	770 246	Ratchet Headgear Assy.	1
8	770 248	Adjustment Angle/Stop Hardware Kit	1
9	770 249	Headband, Fabric	1
10	216 336♦	Comfort Cushion, Foam Rubber	1
11	770 250♦	Bag Helmet, Miller	1
	079 975♦	O-Rings, Replacement (For Item 8) (5 Per Pkg.)	1
	222 003♦	Adapters, Hard Hat (Not Shown)	1
12	212 235♦	Lens, 0.75 Magnification (Not Shown)	1
12	212 236♦	Lens, 1.00 Magnification (Not Shown)	1
12	212 237♦	Lens, 1.25 Magnification (Not Shown)	1
12	212 238♦	Lens, 1.50 Magnification (Not Shown)	1
12	212 239♦	Lens, 1.75 Magnification (Not Shown)	1
12	212 240♦	Lens, 2.00 Magnification (Not Shown)	1
12	212 241♦	Lens, 2.25 Magnification (Not Shown)	1
12	212 242♦	Lens, 2.50 Magnification (Not Shown)	1

♦ Optional

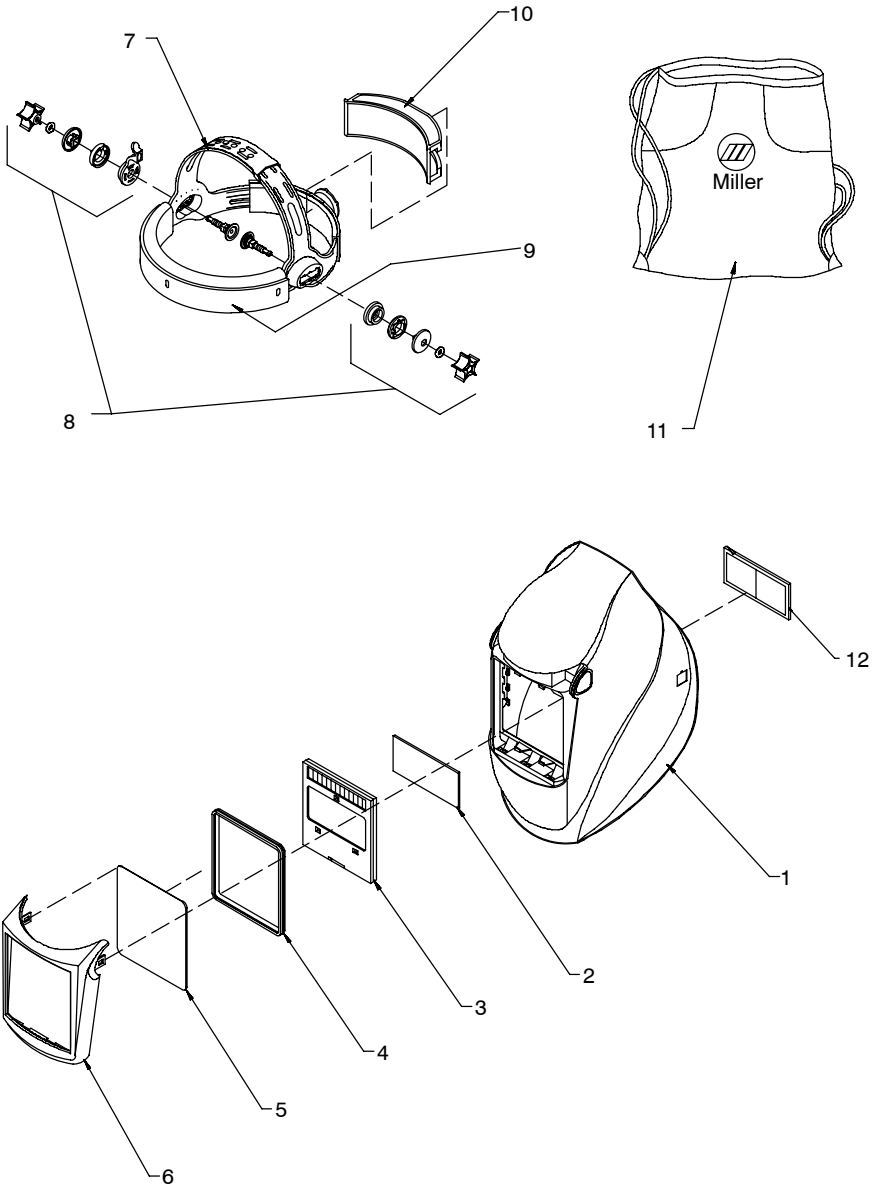

804 814

Figure 11-2. Performance Series Auto-Darkening Welding Helmet

Item No.	Part No.	Description	Quantity
----------	----------	-------------	----------

Figure 11-2. Performance Series Auto-Darkening Welding Helmet

1	232 020	Helmet Shell, Black	1
1	232 021	Helmet Shell, America's Eagle	1
1	232 022	Helmet Shell, Fire Storm	1
1	232 023	Helmet Shell, Millermatic® II	1
1	232 024	Helmet Shell, Motorsports	1
2	770 237	Lens Cover, Inside (4.25 – 2.0 in) (5 Per Pkg.)	1
3	232 026	Auto-Darkening Lens Assy.	1
	232 027	Tray, Battery	1
4	232 028	Gasket, Front Lens	1
5	231 921	Lens, Front Cover (4.5 x 5.5 in) (5 Per Pkg.)	1
6	232 030	Holder, Front Lens (Flat Black)	1
6	232 031	Holder, Front Lens (Gray)	1
6	232 032	Holder, Front Lens (Gloss Black)	1
6	232 033	Holder, Front Lens (Blue)	1
6	232 034	Holder, Front Lens (Yellow)	1
7	770 246	Ratchet Headgear Assy.	1
8	770 248	Adjustment Angle/Stop Hardware Kit	1
9	770 249	Headband, Fabric	1
10	216 336♦	Comfort Cushion, Foam Rubber	1
11	770 250♦	Bag Helmet, Miller	1
	079 975♦	O-Rings, Replacement (For Item 8) (5 Per Pkg.)	1
	222 003♦	Adapters, Hard Hat (Not Shown)	1
12	212 235♦	Lens, 0.75 Magnification	1
12	212 236♦	Lens, 1.00 Magnification	1
12	212 237♦	Lens, 1.25 Magnification	1
12	212 238♦	Lens, 1.50 Magnification	1
12	212 239♦	Lens, 1.75 Magnification	1
12	212 240♦	Lens, 2.00 Magnification	1
12	212 241♦	Lens, 2.25 Magnification	1
12	212 242♦	Lens, 2.50 Magnification	1

♦ Optional

SECTION 12 – LIMITED WARRANTY

Effective January 1, 2006

LIMITED WARRANTY – Subject to the terms and conditions below. Miller Electric Mfg. Co., Appleton, Wisconsin, warrants to its original retail purchaser that the new Miller equipment sold after the effective date of this limited warranty is free of defects in material and workmanship at the time it is shipped by Miller. THIS WARRANTY IS EXPRESSLY IN LIEU OF ALL OTHER WARRANTIES, EXPRESS OR IMPLIED, INCLUDING THE WARRANTIES OF MERCHANTABILITY AND FITNESS.

Miller Pro-Hobby, Performance, and Elite Series auto-darkening lens helmets are warranted for 2 years from the date of purchase. *Proof of purchase is required for warranty transactions so it is imperative that a copy of the original invoice or sales receipt be retained.*

For warranty transactions, contact your Miller Distributor.

NOTES



Visit our website at
www.MillerWelds.com



Miller Electric Mfg. Co.
An Illinois Tool Works Company
1635 West Spencer Street
Appleton, WI 54914 USA